

Technische Daten Trondheim 44-C

Wandaußenmaß: 390 x 390 cm

Bohlenstärke: 44 mm



Kontrolliert durch:

Achtung: Alle angegebenen Maße sind ca.-Maße!

3D-Darstellung und Grundriss Trondheim 44-C

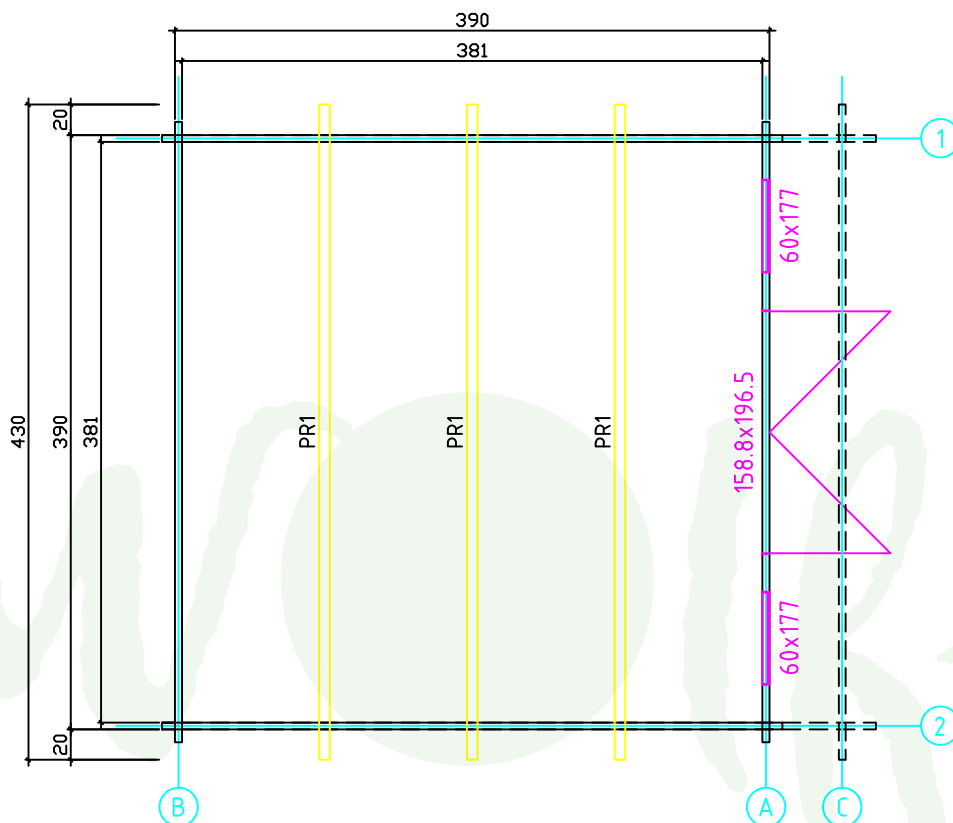
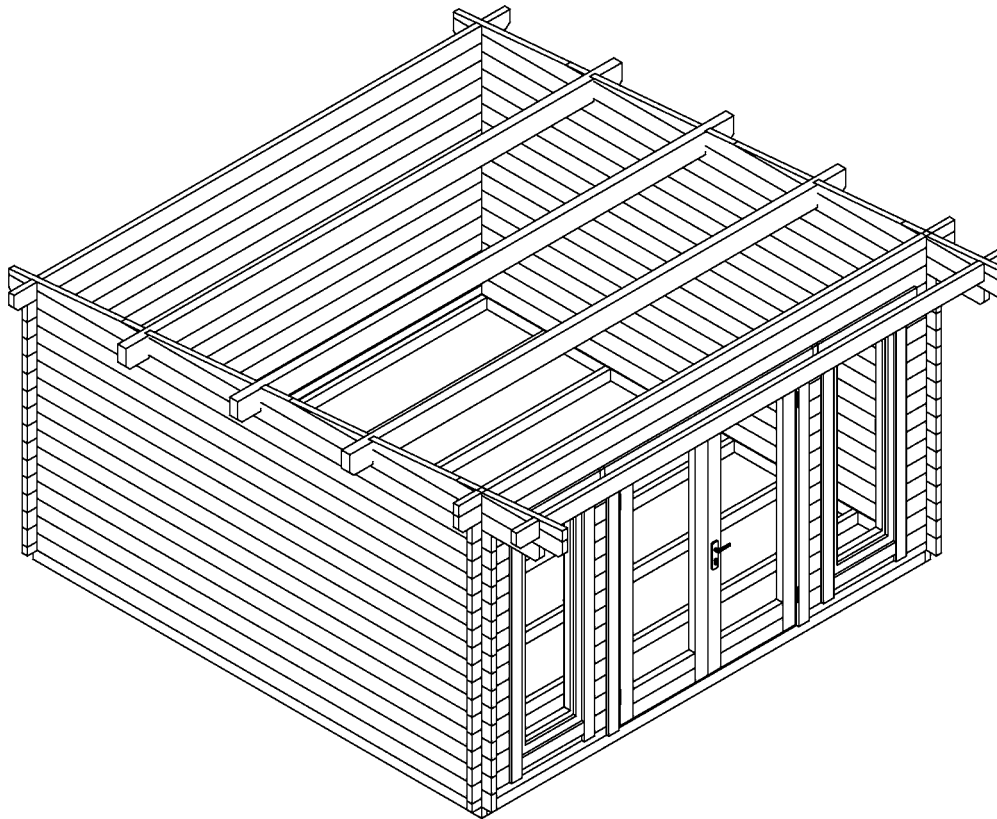





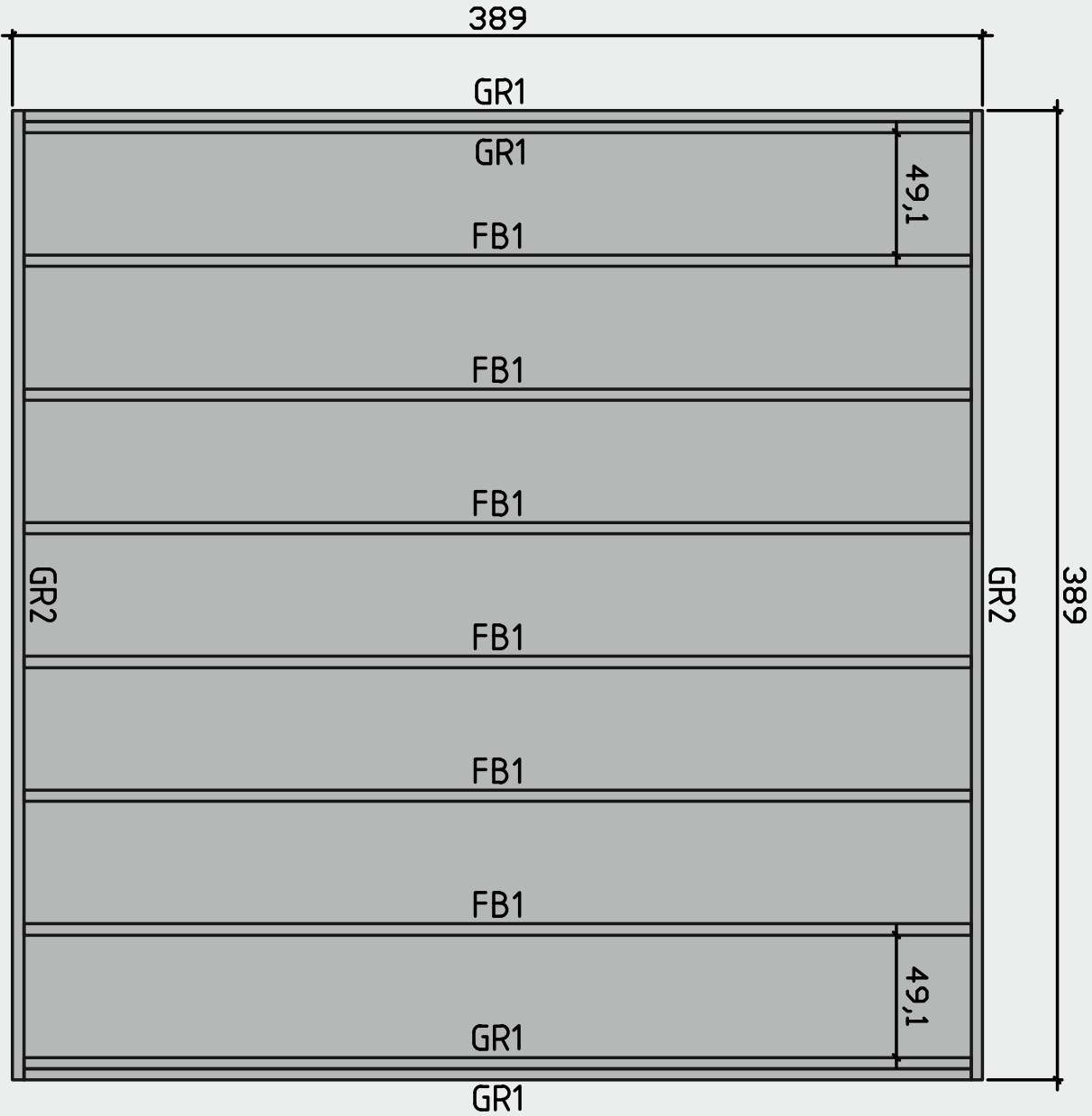







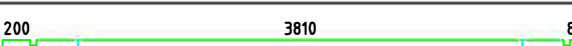

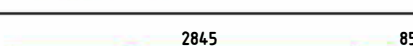

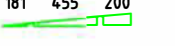

Lagerholzplan und Fundamentplan Trondheim 44-C

Wir empfehlen als Fundament für Ihr Gartenhaus eine vollflächig festgegründete, gepflasterte oder betonierte Fläche.
Wahlweise ist auch ein Punkt- oder Streifenfundament möglich.

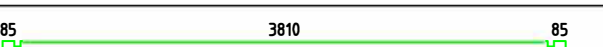
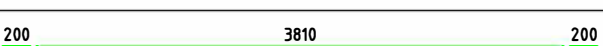
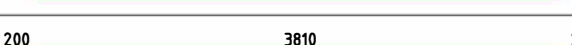
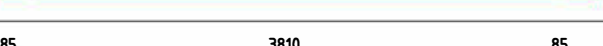
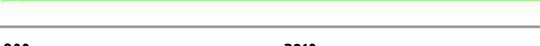

Teileliste 1

Trondheim 44-C

Pos				
001		2	45x130	4070
002		2	45x130	4070
003		24	45x130	4070
004		2	45x130	4185
005		2	45x130	1150
006		2	45x130	2975
007		2	45x16	179
008		2	45x103	940
009		2	45x130	2420
010		2	45x60	667
011		2	45x130	1680
012		2	45x83	926
013		2	45x65	1236
014		2	45x130	1236
015		28	45x130	378
016		28	45x130	248
017		15	45x130	4070
018		1	45x130	4300
019		1	45x85	4300
020		1	45x65	4070
021		2	45x130	4300
GR2		2	45x90	3890
GR1		4	45x90	3800
FB1		6	45x90	3800
PR1		3	70x170	4300

Teileliste 3 Trondheim 44-C

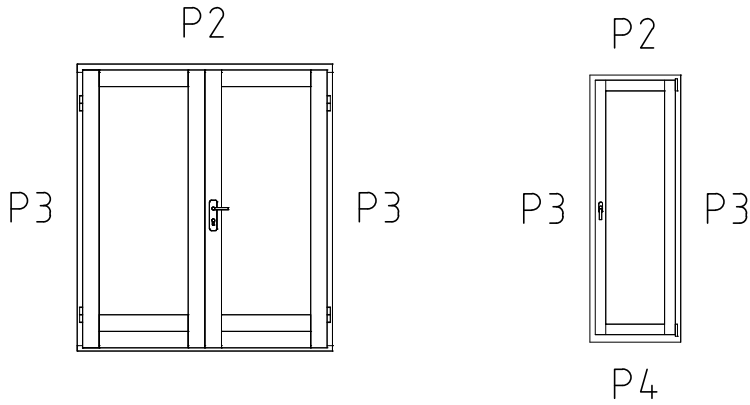
POS	ST.	B	H	L	Teileliste
FB1	Vt. spetsi				FUNDMENTHOLZER
F1	14,5m ²	28		3805	FUSSBODENBRETTER
PR	3	70	170	4300	DACHBALKEN
RB1	20,7m ²	20		4819	DACHBRETTER
R1	2	20	140	4340	Vaata katuse kaldenurka Traufenbretter
R2	2	45	65	4300	Vaata katuse kaldenurka Traufenbretter
R3	2	20	140	5020	Vaata katuse kaldenurka Giebelabschlussleiste
R4	2	20	90	5020	Giebelabschlussleiste
DR1 WN1	1 2	1588 600	1965 1770		
P1	17m	20	40		Fußbodenleiste
P2	1+1	20	90	3800	Türleiste DR1, Fensterleiste WN1
P3	6+6	20	90	1945	Türleiste DR1, Fensterleiste WN1
P4	2+2	20	90	540 570	Fensterleiste WN1

Wandplan 1 und 2 Trondheim 44-C

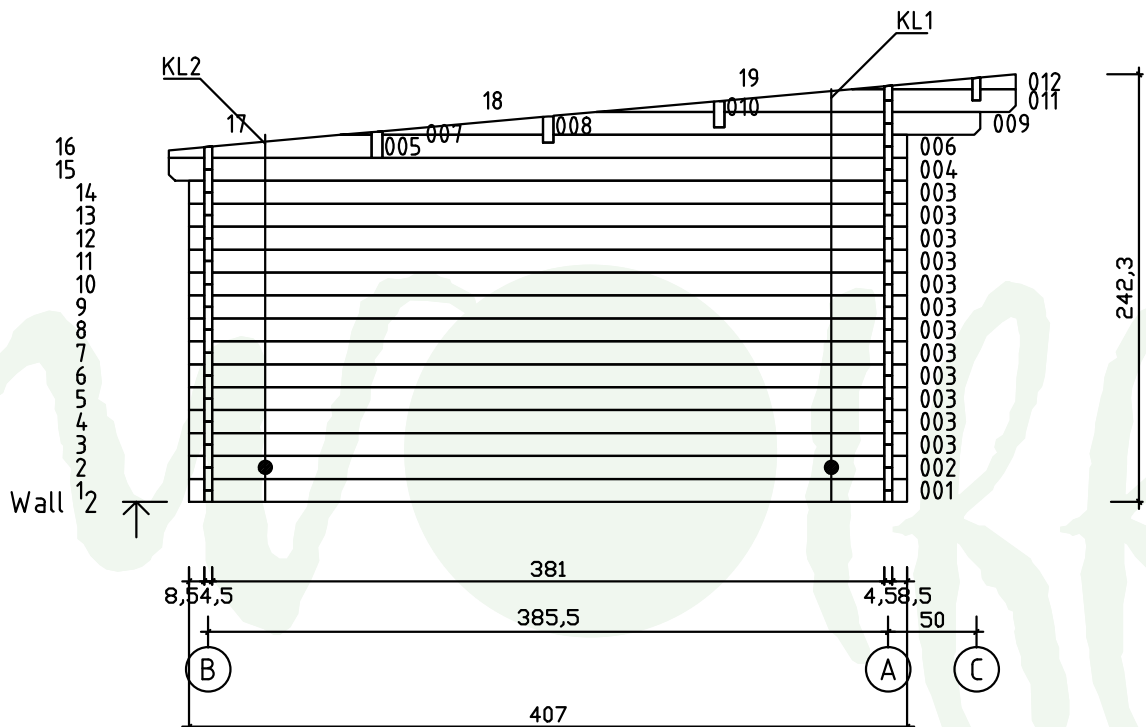
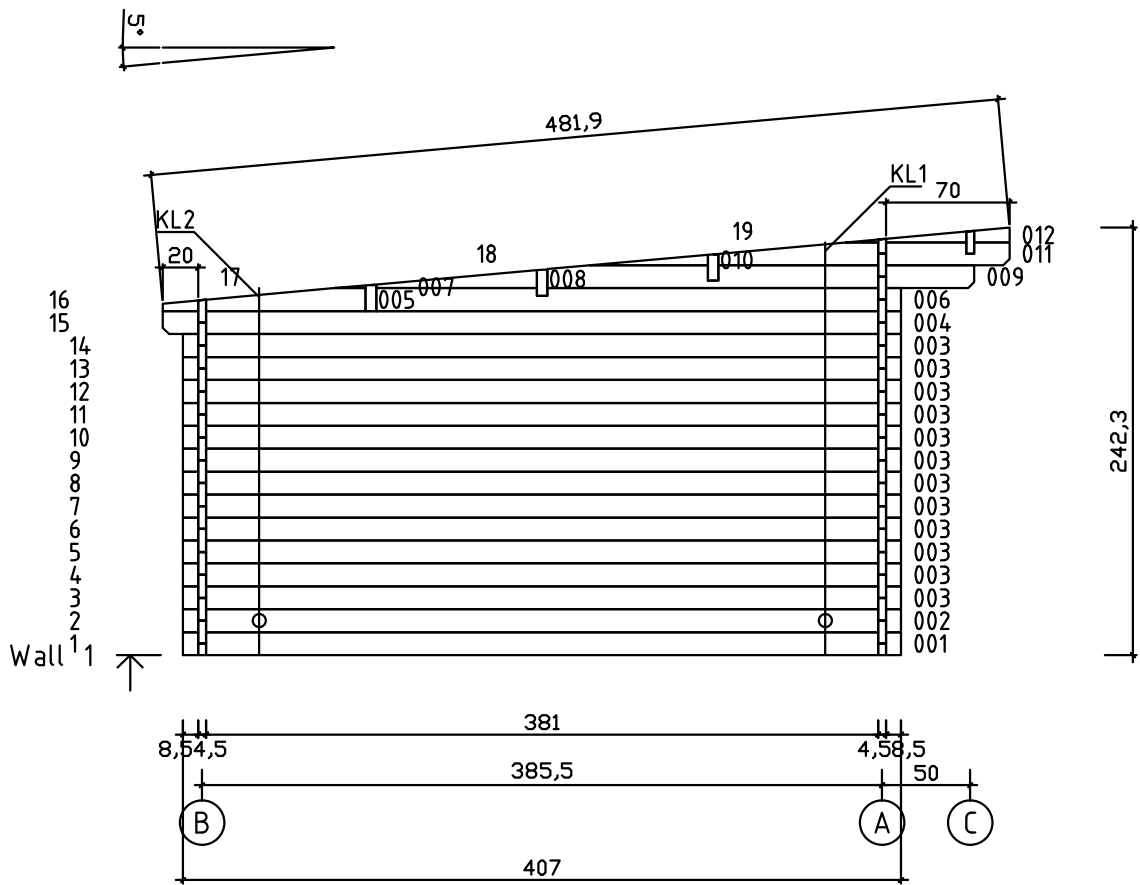

Wandplan A und B Trondheim 44-C

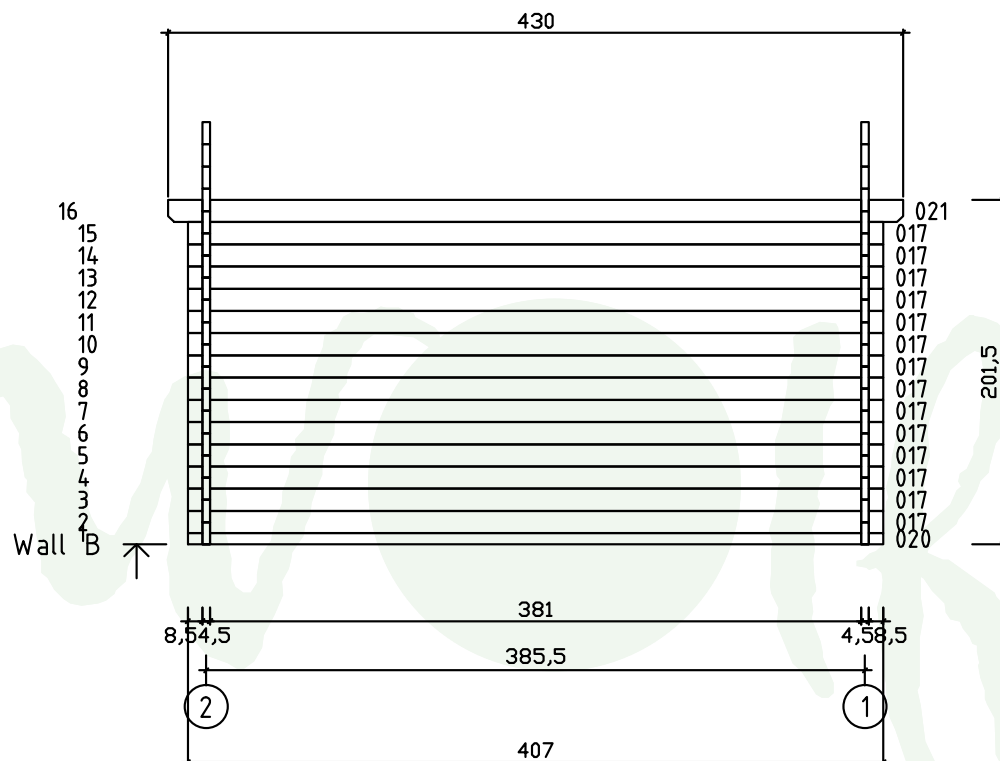
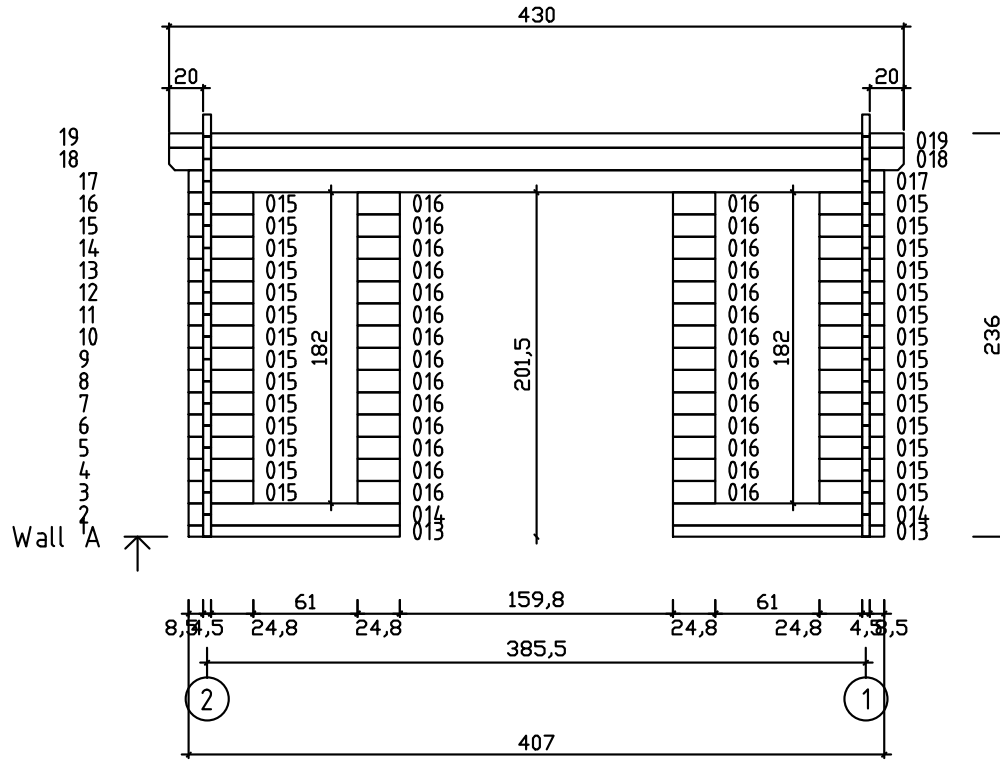

Wandplan C Trondheim 44-C

Vorgelagerte Vordachbohle vor Wand A

