





Mehr Produkte finden Sie  
in unserem Katalog!

Art. 870 110

# Nordkap 70-B

70 mm / 360x360 cm / 13,0 m<sup>2</sup>



## DIMENSIONEN

	Bohlenstärke	70 mm
	Innenmaß	346x346 cm
	Sockelmaß	360x360 cm
	Gesamtmaß	410x530 cm
	Grundfläche	13,0 m <sup>2</sup>
	Rauminhalt	27,6 m <sup>3</sup>
	Firsthöhe	254 cm
	Seitenwandhöhe	208 cm
	Dachüberstand vorne/seitlich/hinten	150/25/20 cm

## DACH

	Dachneigung	15°
	Dachfläche	22,5 m <sup>2</sup>
	Dachbretter	20 mm



## TÜR/ FENSTER

	Doppeltür (Isoglas)	144,8x186,5 cm
	Doppelfenster (1 Stück, isolierverglast, <b>Einhand-Dreh-/Kipp</b> )	117x89,5 cm
	Einzelfenster (1 Stück, isolierverglast, <b>Einhand-Dreh-/Kipp</b> )	62,5x81,6 cm

## FUSSBODEN

	Fußbodenbretter	28 mm
--	-----------------	-------

## VERPACKUNG

	Paketabmessung	643x117x74 cm
	Paketgewicht	1.700 kg

## ZUBEHÖR (zzgl.)

	6 Rollen Dachpappe zu 6 m 9 VE Dachschindeln <b>Dachrinne</b> Kunststoff 322B mit KS- Ergänzungsset K4B, anthrazit Alu bis 600 cm mit 2 Fallrohren Terrasse 70.2 asymmetrisch
--	---

**5 JAHRE  
GARANTIE**



## Grundriss

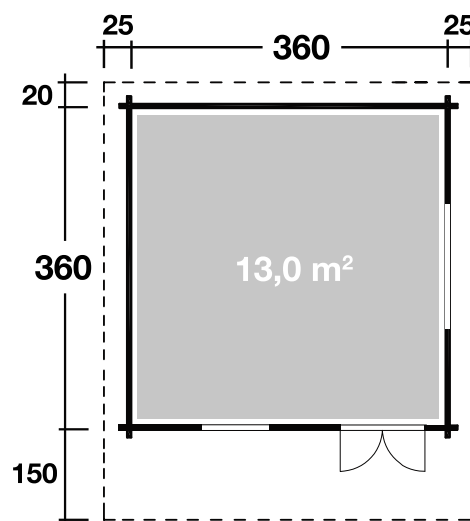

Weitere Informationen finden Sie unter: [www.finnhaus.de](http://www.finnhaus.de) oder im aktuellen Katalog.  
Technische Änderungen, Druckfehler und Irrtümer vorbehalten.